

Business Market & Outlook

August 2014



Disclaimer

The business results are subject to the IFRS(International Financial Reporting Standards) from 2010. In addition, operating profits are amended to reflect revisions of “K-IFRS, No. 1001” decided on 19th regular Financial Services Commission’s meeting on October 17th 2012 and “Guidance for public announcements of business results” reported by KAI(Korea Accounting Institute) on Feb 18th 2013.

Forecasts and projections contained in this material are based on current business environments and management’s strategies, and they may differ from the actual results upon changes and unaccounted variables.

Table of Contents

LG Chem at a Glance	1
2Q 2014 Business Results	3
Divisional Results & Outlook	5
Appendix	7

LG Chem at a Glance

- LG Chem was started in 1947 and is Korea's first and largest chemical company with an established track of over 60 years and annual revenues of KRW 23.1 trillion in 2013.
- LG Chem boasts multiple production facilities and an extensive distribution network that spans 15 countries worldwide in Asia, Europe, North and South America.
- LG Chem currently holds the largest vertically integrated petrochemical production platform in Korea.
- LG Chem was reborn as a specialized and diversified chemical company that focuses on petrochemical goods, rechargeable batteries including HEV/EV purpose, OLED materials, and 3D FPR.
- LG Chem will seek operational excellence in its core business and centralize its resources with new business such as xEV batteries and LCD glass substrates to reinforce the necessary momentum for future growth.
- Despite high uncertainties remaining in the business environment such as delayed recovery in the global economy, LG Chem is recording robust profitability compared to peers.

Revenue Growth*

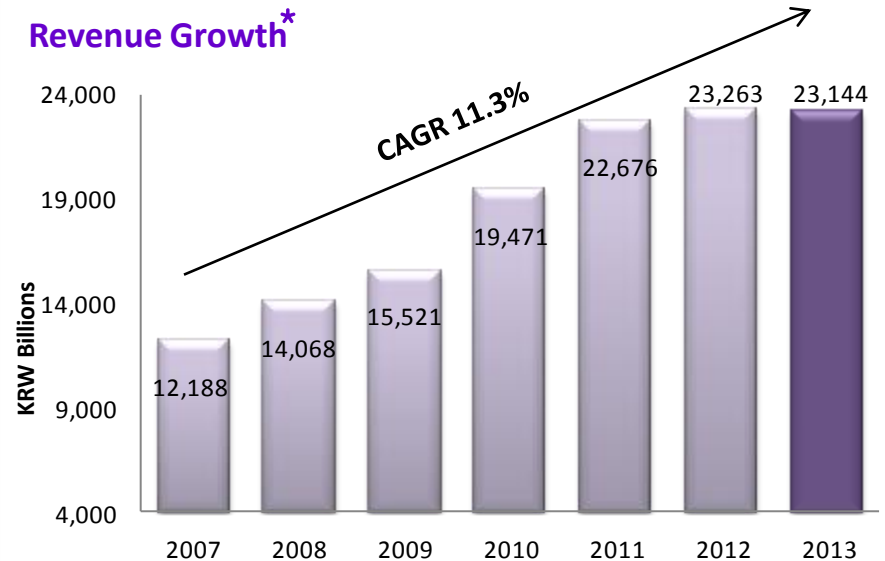

...with Strong EBIT & EBIT Margins*

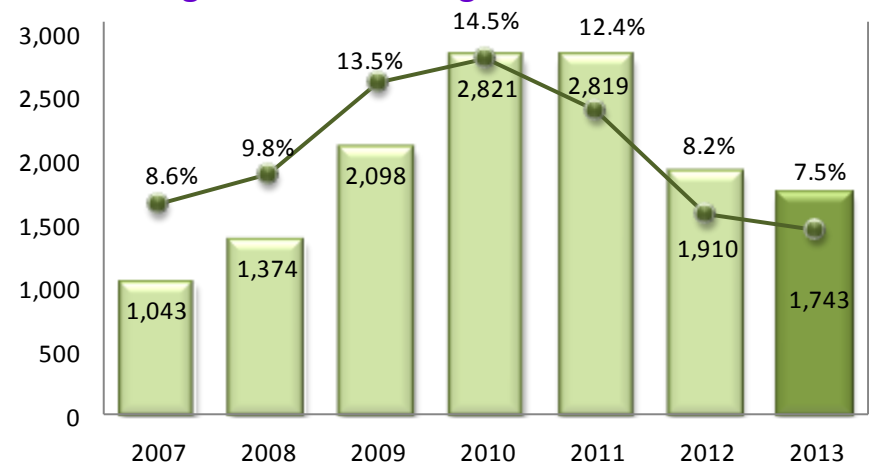

* Sales and EBIT are subject to IFRS from 2009. Those prior to 2009 are subject to K-GAAP(consolidated base).

Differentiated Competitiveness

Vertical Integration Structure

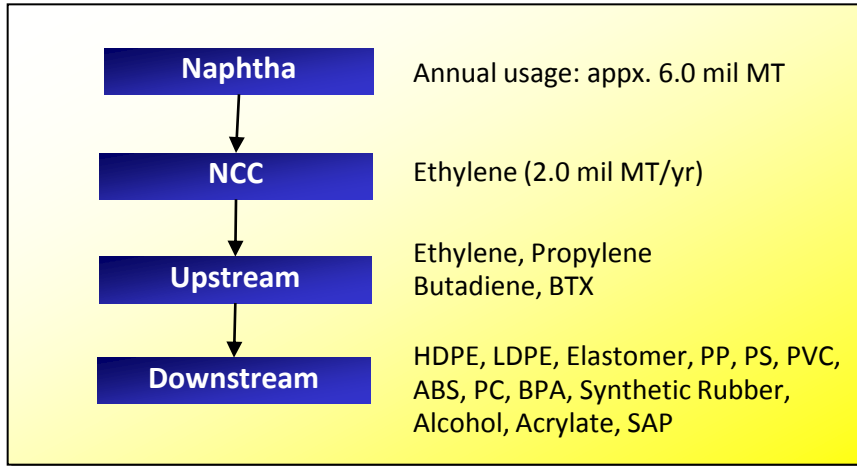

Co-existence of upstream and downstream products

- One of few petrochemical companies around the globe with vertical integration structure, featuring both upstream and downstream production capability.
- This structural characteristic delivers stable business performance against industry cyclicality.

Comprehensive downstream product lines

LG Chem's comprehensive downstream product lines of PO, ABS, PVC and other various products have complementary business cycles, enabling the Company to generate stable revenue



Stabilized revenue generating capability under any market conditions

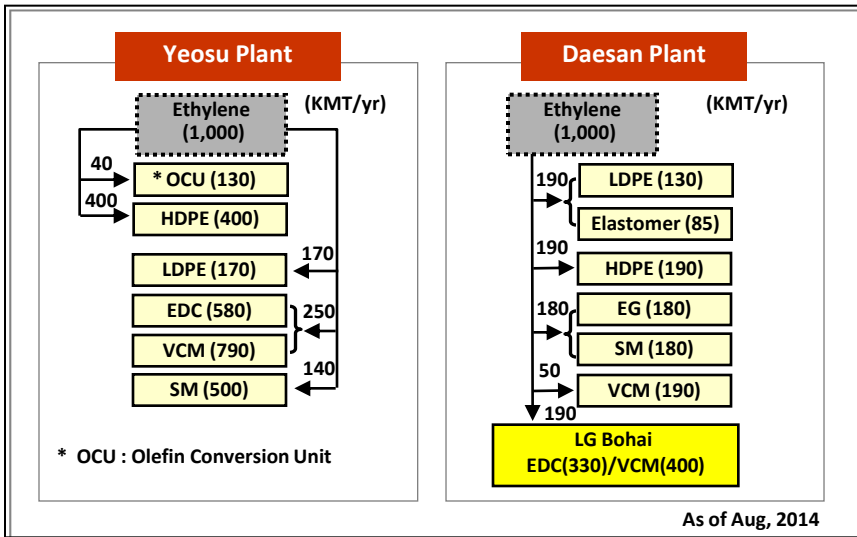

(Unit: KRW bn)

Classification	'13.2Q	'14.1Q	'14.2Q	YoY	QoQ
Sales	5,917	5,673	5,869	-0.8%	3.5%
Operating Profit	502	362	360	-28.3%	-0.7%
(%)	(8.5)	(6.4)	(6.1)		
Pre-tax Income	510	354	290	-43.1%	-18.1%
(%)	(8.6)	(6.2)	(4.9)		
Net Income	401	286	227	-43.4%	-20.7%

Financial Position

(Unit: KRW bn)

Classification	'13	'14.2Q	Change
Asset	17,447	17,664	1.2%
Cash and equivalents	1,909	1,859	-2.6%
Liabilities	5,721	5,830	1.9%
Borrowings	3,011	3,077	2.2%
Shareholder's Equity	11,726	11,834	0.9%
EBITDA	2,788	1,264	

Financial Ratios

Classification	'13	'14.2Q	Change
Total Liabilities/ Equity (%)	48.8	49.3	0.5%p
Borrowings / Equity (%)	25.7	26.0	0.3%p
Interest Coverage Ratio (x)	26.7	17.3	-9.4
ROE (%)	11.3	8.7	-2.6%p
ROA (%)	7.5	5.8	-1.7%p

Business results

(Unit: KRW bn)

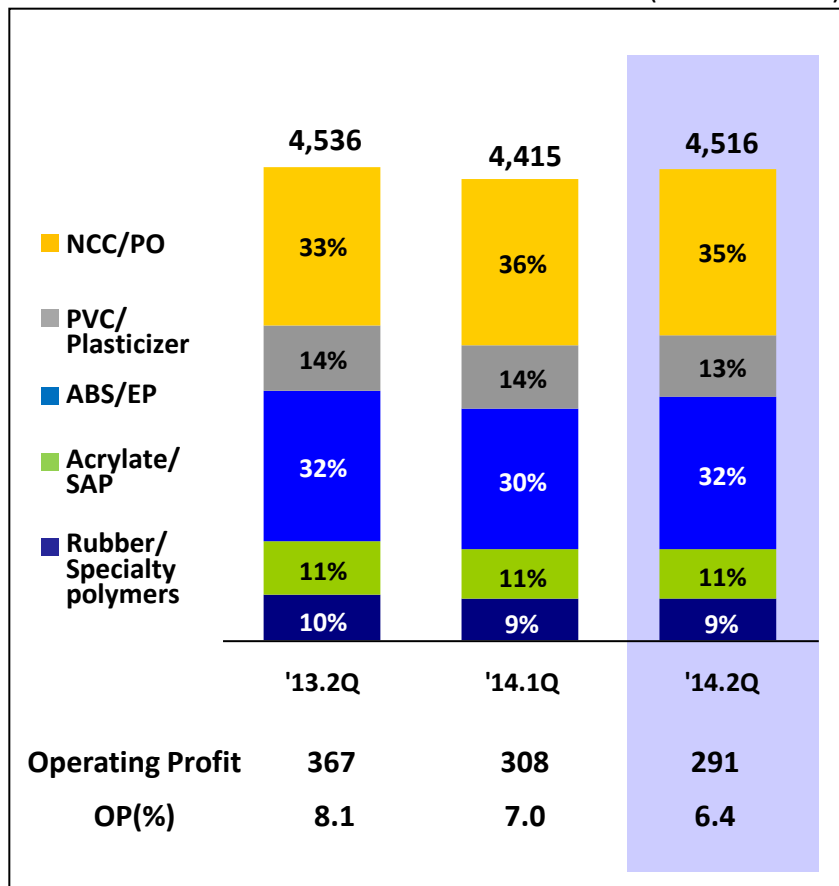

Analysis

• Analysis

- **Earnings declined due to delayed market recovery and strong Korean won**

-NCC/PO : Maintained sound profitability thanks to tight supply of ethylene and seasonal demand increase

-PVC/Plasticizer : Delayed recovery of product price because of sluggish demand in China

-ABS/EP : Continued stable performance backed by increases in HA demand and premium product sales

-Acrylate/SAP : Continued solid earnings with capacity expansion of SAP and sales increase to strategic customers

-Rubber/Specialty Polymers : Margin declined by price weakness due to excess supply

• Outlook

- **Expect gradual market recovery with seasonal demand despite rises in naphtha costs**

- **Enhance competitive edge through high margin products and differentiated product portfolio**

Business results

Analysis

(Unit: KRW bn)

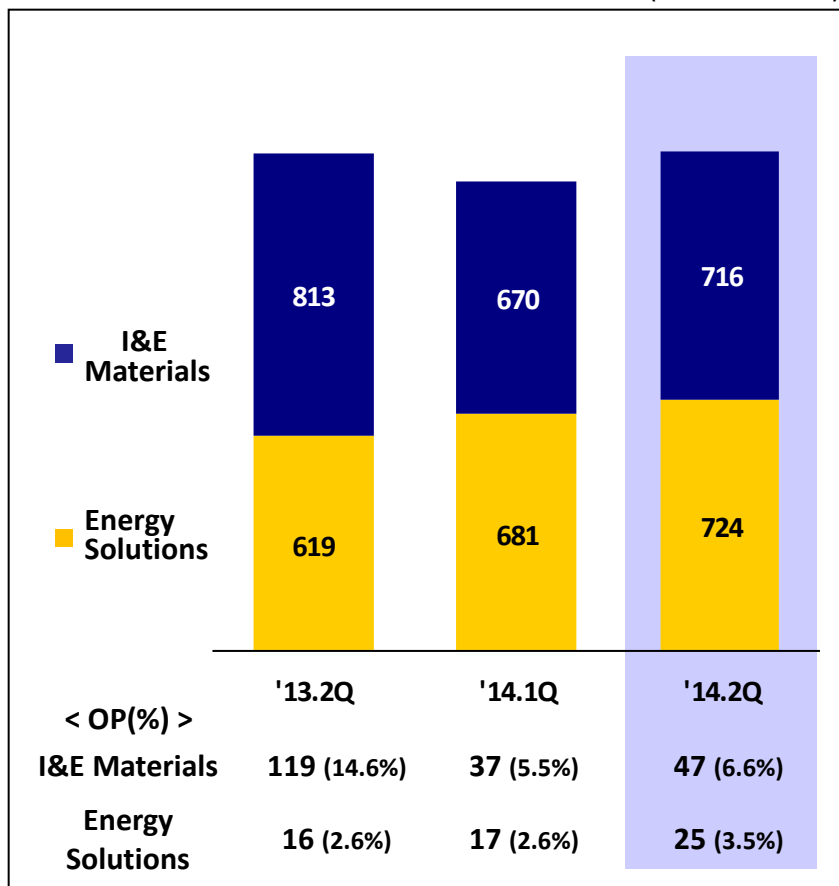

• Analysis

- **I&E Materials** : Shipments increased with seasonal demand and expanded high-profit products sales such as 3D-pol, acrylic polarizers
- **Energy Solutions** : Earnings improved by well-balanced supply and demand and rise of utilization rate with increased battery shipments ; Cylindrical for Power Banks, Wide prismatic for Slim PCs, and Polymer for Smart Phones

• Outlook

- **I&E Materials** : Expect earning improvement by ramping up new polarizer line in Nanjing & cost reduction
- **Energy Solutions** : Expand proportion of high-profit products such as stepped battery and increase shipments with customers' new product launch & continue to secure new customers of automotive battery

(Unit: KRW bn)

Classification	2013					2014				
	1Q	2Q	3Q	4Q	Total	1Q	2Q	3Q	4Q	Total
Sales	5,721	5,917	5,865	5,641	23,144	5,673	5,869			11,542
Operating Profit	409	502	516	316	1,743	362	360			722
Petrochemicals	4,353	4,536	4,426	4,300	17,614	4,415	4,516			8,931
NCC/PO	1,470	1,509	1,517	1,540	6,036	1,586	1,583			3,169
PVC/Plasticizer	598	620	611	580	2,409	601	595			1,196
ABS	1,082	1,165	1,099	1,051	4,396	1,066	1,148			2,215
EP	265	282	284	271	1,102	282	298			581
Acrylate/SAP	492	511	504	460	1,966	474	485			958
Rubber/ Specialty Polymer	446	450	412	398	1,706	406	407			813
Operating Profit	324	367	380	262	1,332	308	291			599
I&E Materials	827	813	788	737	3,166	670	716			1,386
Operating Profit	97	119	102	61	379	37	47			84
Energy Solutions	592	619	708	665	2,583	681	724			1,405
Operating Profit	-12	16	34	-6	32	17	25			42

※ 2013 Petrochemicals business results are amended to reflect reorganization of the division.

Borrowings

(Unit : KRW bn)

Classification	'13	'14.1H
Total (Overseas Subsidiaries)	3,011 (1,172) 100%	3,077 (1,112) 100%
KRW Currency	803 27%	803 26%
C P	599	599
Others	205	204
Foreign Currency	2,207 73%	2,274 74%
Loan	1,272	1,208
Negotiation Borrowings	935	1,066
Short-term (Overseas Subsidiaries)	2,207 (1,074) 73%	2,190 (827) 71%
Long-term (Overseas Subsidiaries)	803 (98) 27%	887 (285) 29%

* The % is calculated to total borrowings.

Cash Flow

(Unit: KRW bn)

Classification	'13	'14.1H
Beginning Cash	1,341	1,909
Operating/Investing	813	178
Net Income	1,271	513
Depreciation	1,045	542
Working Capital	-280	-73
CAPEX	-1,380	-732
Others	157	-72
Financing	-245	-228
Borrowings	64	66
Dividends	-308	-295
Ending	1,909	1,859

(Unit: KRW bn)

Classification		'12	'13	'14 Plan	'14.1H
Petrochemicals	New / Expansion	791	416	499	143
	Maintenance	177	213	394	105
	Total	969	629	894	249
I & E Materials	New / Expansion	253	269	454	67
	Maintenance	71	94	132	69
	Total	324	363	586	136
Energy Solutions	New / Expansion	431	104	76	77
	Maintenance	106	106	125	62
	Total	537	209	200	139
Common Expenses	New / Expansion	162	116	181	184
	Maintenance	105	64	91	25
	Total	267	180	271	209
Total	New / Expansion	1,615	904	1,210	471
	Maintenance	460	476	741	261
	Total	2,075	1,380	1,951	732

※ "New/Expansion" includes R&D investments.

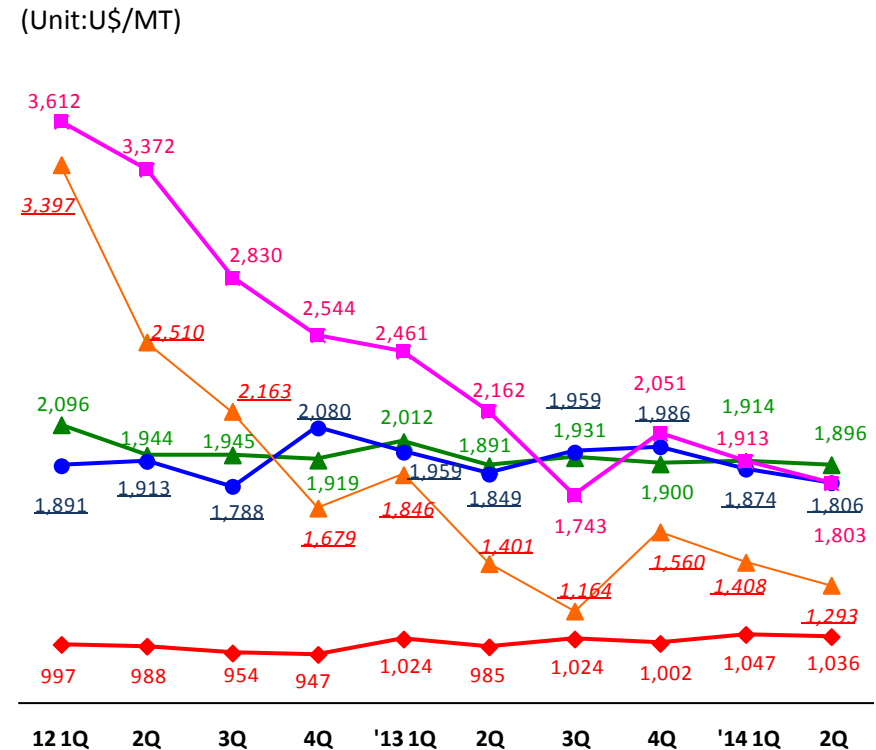
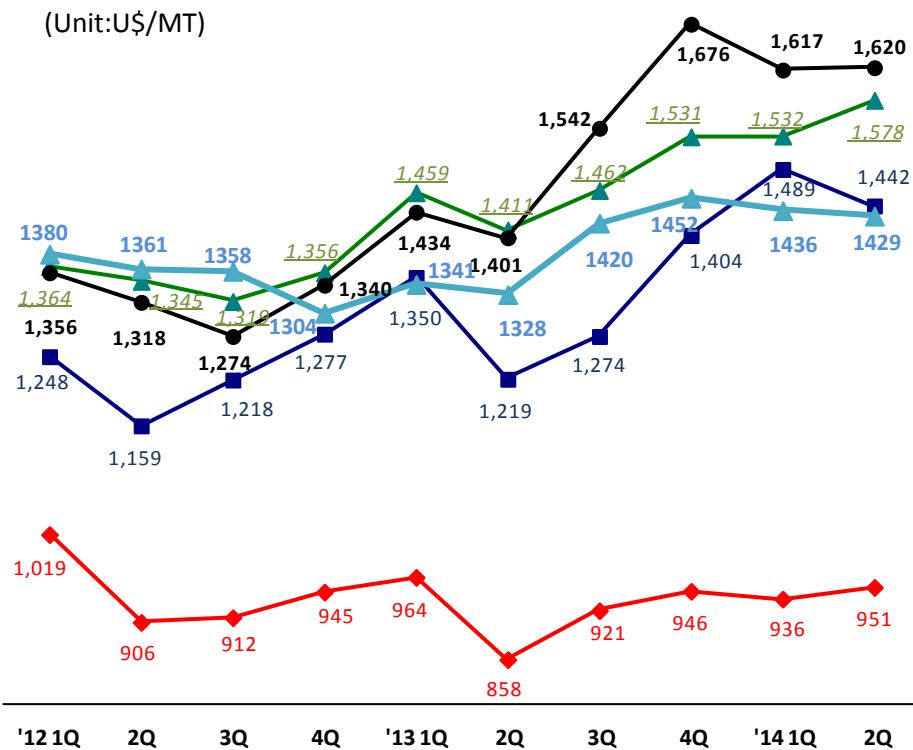

◆ Naphtha ■ Ethylene ▲ HDPE(Film) ● LDPE ▲ Propylene

◆ PVC ▲ ABS ● B.Acrylate ▲ BD ■ BR

NCC/PO

PVC/
Plasticizer

ABS/EP

Acrylate/
SAP

Rubber/
Specialty Polymers

• The prices are average price of CFR FE Asia for general grade in each product group.

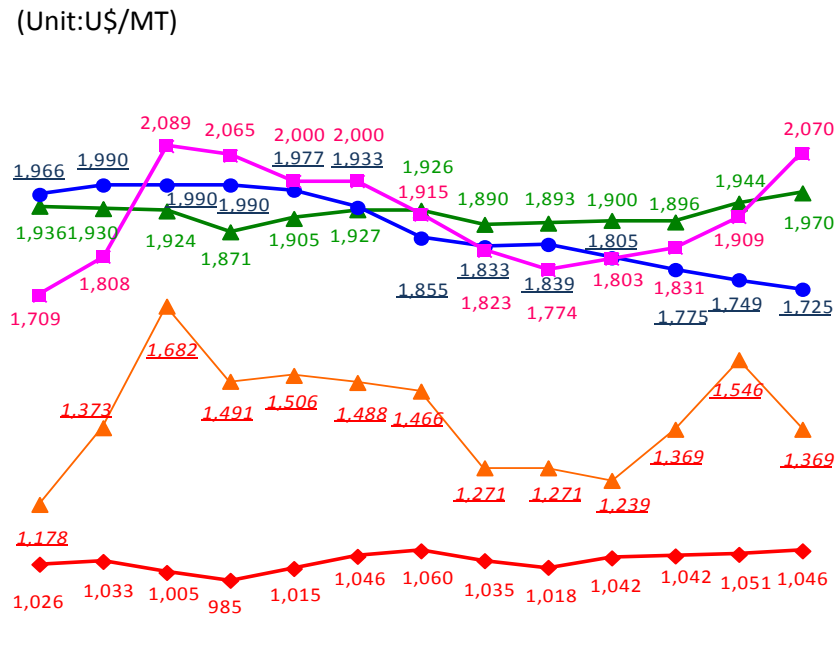
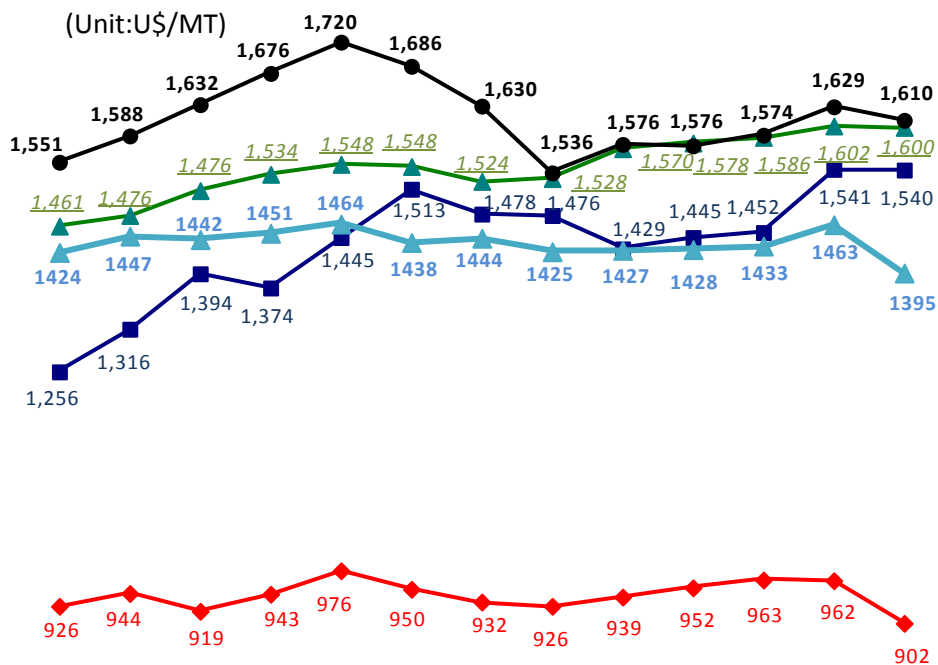

◆ Naphtha ■ Ethylene ▲ HDPE(Film) ● LDPE ▲ Propylene

◆ PVC ▲ ABS ● B.Acrylate ▲ BD ■ BR

NCC/PO

PVC/
Plasticizer

ABS/EP

Acrylate/
SAP

Rubber/
Specialty Polymers

• The prices are average price of CFR FE Asia for general grade in each product group.

* Shows the prices on August 15, 2014